



SSI AERATION, INC.

Innovative Aeration Systems for Wastewater Treatment

- Complete aeration systems
- Fine and Coarse Bubble Diffusers
- Membranes and spare parts
replacment
- Retrievable system
- MBBR Technology



SSI AERATION, INC.
WWW.SSIAERATION.COM
INFO@SSIAERATION.COM



OVER 25 YEARS EXPERIENCE

**WHY SSI?
INNOVATION
RELIABILITY
EXPERIENCE
IN-HOUSE
MANUFACTURING**

Founded in 1995 in Poughkeepsie, NY, USA, SSI is known for the quality of its products and level of service provided to our customers.

Since 1995 SSI Aeration has expanded to include multiple offices and distribution centers around the world. Our team includes a full-service engineering department that can provide our clients process calculations, BioWin drawings and simulations, and access to innovative on-line design tools.

- Production and warehouses worldwide
- 5 molding machines for plastic + for rubber
- Automatic robotic assembling
- Production capacity up to 1.1 million disc diffusers + 300000 tube diffusers per year
- Global presence with local branches in Italy, USA, India, South Korea, Dubai and China
- ISO 9001:2015 certification



WHY PTFE?

SSI's patented PTFE membrane has changed the way people look at diffuser membranes.

EPDM membranes alone can absorb liquid in situ, releasing plasticizers in the rubber and losing their efficiency overtime.

It is not uncommon over the lifespan of EPDM membranes to see increase in pressure drops and a reduction in SOTE.

WHY COMBINE PTFE WITH EPDM?

PTFE is a hydrophobic material that protects the EPDM rubber. What does coating the membrane with PTFE help?

- Slow Migration of plasticizers from the EPDM membrane.
- Reduce rate of biofouling or clogging by biological material
- Mitigate effects of harsh chemicals that may be present in wastewater

PTFE membranes are an ideal choice for industrial applications and can help extend the lifespan of the aeration system.

ADVANTAGES

- Single mold technology to reduce costs
- Available in 4 versions 7", 9" , 12" and 20"
- 3/4" M NPT connection
- High efficiencies (SOTE) and low pressure drops tested according to ASCE standards
- High resistance environmentally friendly polypropylene body (100 ° C)
- Membrane with low plasticizer content to minimize the phenomena of loss of elasticity and shrinkage

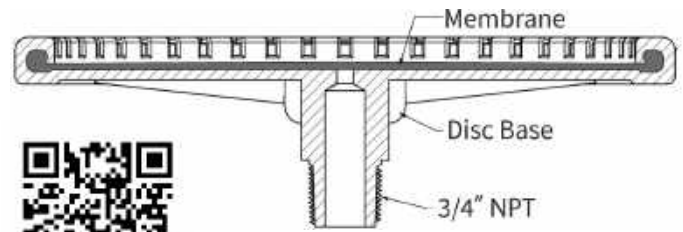

The QR code connects to the site <https://curvegen.ssiaeration.com/> where you can check SOTE and pressure drops

MEMBRANE

MATERIAL	PRICE	LIFESPAN	MUNICIPAL	INDUSTRIAL
EPDM	● ● ●	● ● ●	● ● ●	● ●
PTFE	● ●	● ● ●	● ● ●	● ● ●
SILICONE	●	● ●	●	● ● ●
POLYURETHANE	●	● ●	●	● ● ●

EPDM and PTFE available in stock
SILICONE and POLYURETHANE on request



MODEL	SLIT SIZE	DESIGN FLOW	DESIGN RANGE	ACTIVE SURFACE AREA	CONNECTION	WEIGHT
7" ECD215	1 MM	0.5 - 2.0 SM3/H	0.3- 3.5 SM3/H	0,0375 M2	3/4" M NPT	370 GR
9" ECD270	1 MM 2 MM	2.5 - 5.0 SM3/H 4.0 - 6.5 SM3/H	1.0 - 7.0 SM3/H 1.5 - 12.0 SM3/H	0,0375 M2	3/4" M NPT	470 GR
12" ECD350	1 MM	4.0 - 8.5 SM3/H	1.0 - 13.0 SM3/H	0,065 M2	3/4" M NPT	630 GR

ECD SERIES

SINGLE MOLD DISC DIFFUSERS

ADVANTAGES

- 3-piece technology, Membrane can be replaced
- Available in 2 versions, 9" and 12"
- 3/4" M NPT connection
- POD version available pre-assembled on pipe
- High efficiencies (SOTE) and low pressure drops tested according to ASCE standards
- High resistance "environmentally friendly" polypropylene body (100 ° C)
- Membrane with low plasticizer content to minimize the phenomena of loss of elasticity and shrinkage

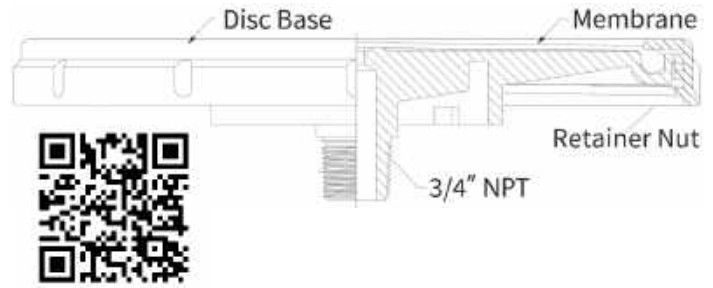

The QR code connects to the site <https://curvegen.ssiaeration.com/> where you can check SOTE and pressure drops

MEMBRANE

MATERIAL	PRICE	LIFESPAN	MUNICIPAL	INDUSTRIAL
EPDM	●●●	●●	●●●	●●
PTFE	●●	●●●	●●●	●●●
SILICONE	●	●●	●	●●●
POLYURETHANE	●	●●	●	●●●

EPDM and PTFE available in stock
SILICONE and POLYURETHANE on request



MODEL	SLIT SIZE	DESIGN FLOW	DESIGN RANGE	ACTIVE SURFACE AREA	CONNECTION	WEIGHT
9" AFD270	1 MM 2 MM	2.5 - 5.0 SM3/H 4.0 - 6.5 SM3/H	1.0 - 7.0 SM3/H 1.5 - 12.0 SM3/H	0,0375 M2	3/4" M NPT	680 GR
12" AFD350	1 MM	4.0 - 8.5 SM3/H	1.0 - 13.0 SM3/H	0,065 M2	3/4" M NPT	1400 GR

2 mm slits available on project

AFD SERIES

Disc Diffusers

ADVANTAGES

- Single mold technology to reduce costs
- Revolutionary "half moon" shape to reduce the coalescence phenomenon typical of tubular diffusers
- High efficiencies (SOTE up to 8% / m) and reduced pressure drops tested according to ASCE standards
- High resistance "environmentally friendly" polypropylene body (100 ° C)
- Membrane with low content of plasticizers to reduce shrinkage and loss of elasticity
- Connects with 3/4" F NPT connection or 4" saddle (Set)
- Cost effective solution to replace traditional tubes

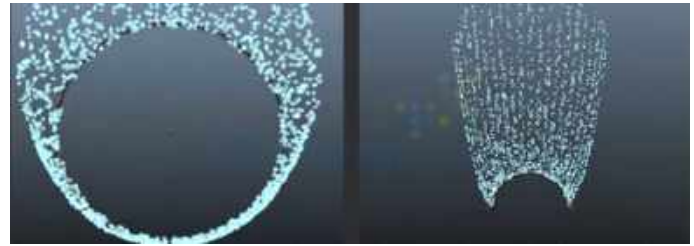

On the left a standard tubular diffuser where the coalescence bubbles at the bottom, reduces the overall efficiency. On the right, the new ECT70 that guarantees maximum efficiency

MEMBRANE

MATERIAL	PRICE	LIFESPAN	MUNICIPAL	INDUSTRIAL
EPDM	●●●	●●	●●●●	●●
PTFE	●●	●●●●	●●●●	●●●●
SILICONE	●	●●	●	●●●●
POLYURETHANE	●	●●	●	●●●●

EPDM and PTFE available in stock
SILICONE and POLYURETHANE on request



The QR code connects to the site <https://curvegen.ssiaeration.com/> where you can check SOTE and pressure drops

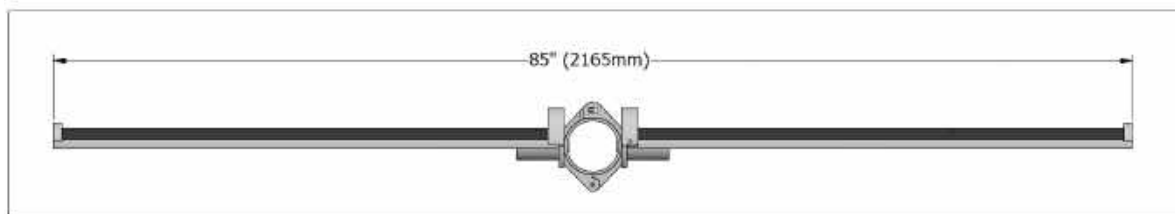

MODEL	SLIT SIZE	DESIGN FLOW	DESIGN RANGE	ACTIVE SURFACE AREA	CONNECTION	WEIGHT
ECT 70	1 MM	1.7 - 9.5 SM3/H	1.5 - 20.4 SM3/H	0,1 M2	3/4" F NPT(*)	3700 GR
	2 MM	3.5 - 13.5 SM3/H	2.5 - 25 SM3/H			

Data referred to a diffuser L = 1 m
(*) for single diffuser. Saddle mount D110 / 114.3 for mounting in pairs (set)

ECT70

Single Mold Tube Diffuser

ECT DIFFUSERS VS PANELS

	ECT70	PANEL
PIPING SYSTEM REQUIRED	PVC or Steel in (D110mm), Pipes affixed to floor using support stands	Polyethylene Pipe with Support Stands
MEMBRANE MATERIAL	EPDM (cost effective), PTFE (long life) silicone, PU	PU
IN OPERATION	Reduced stress on the membrane thanks to small size (1 meter length)	Long lengths (up to 4 meters) with high pressure drops outside of normal operating ranges
INSTALLATION COST	Single mold diffusers offer economical solution for a complete system	High cost for diffusers reduces budget available for piping and system assembly
EFFICIENCY	To fully compare the efficiency of both diffusers you have to consider the SOTE but also the energy efficiency in terms of KgO2/kwh (SAE)	



ECT70

Single Mold Tube Diffuser

ADVANTAGES

- Typically used in equalization, sand removal, or aerobic digestion. They are an interesting solution in oxidation with high solids contents (very low α values)
- High mixing capacity
- Reduced pressure losses
- They allow moderate oxygenation of the sludge to prevent bad odors (typically 1.7% <SOTE <2.5% / m)
- Minimal maintenance required

AFC75

- Economic and durable solution
- 3 "diameter (75mm)
- 3/4" M NPT connection
- 10 \varnothing 5mm holes on the membrane for a even distribution of air
- Body in black acrylic plastic with UV protection
- Flow rates between 0 and 17 Sm³ / h



RELIA BALL

- Innovative non-clogging design ideal for on/off operation
- 3 "diameter (75mm)
- 3/4" M NPT connection
- ABS body
- Membrane available in EPDM and PTFE
- Flow rates between 0 and 34 Sm³ / h



WBCB

- Entirely in SS 304 (316 on request)
- 3/4" M NPT connection
- Length 606 mm with calibrated holes for a homogeneous distribution of the air
- Flow rates between 0 and 67 Sm³ / h

COARSE BUBBLE DIFFUSERS



ADVANTAGES

- Tubes feature channel style body to reduce strain on the membranes particularly in on/off operation
- Diameter 2"(62 mm) and 3" (90 mm);
- Saddle connection for 4" pipe to reduce installation time, also available with 3.4" NPT connection
- High Efficiency (SOTE) and low pressure drops tested according to ASCE standards
- ABS body temperature resistant up to 100 ° C
- Membrane with low plasticizer content to reduce shrinkage and loss of elasticity



The QR code connects to the site <https://curvegen.ssi-aeration.com/> where you can check SOTE and pressure drop

MEMBRANE

MATERIAL	PRICE	LIFESPAN	MUNICIPAL	INDUSTRIAL
EPDM	●●●●	●●●●	●●●●	●●●●
PTFE	●●●●	●●●●	●●●●	●●●●
SILICONE	●●●●	●●●●	●●●●	●●●●
POLYURETHANE	●●●●	●●●●	●●●●	●●●●

EPDM and PTFE available in stock
SILICONE and POLYURETHANE special order

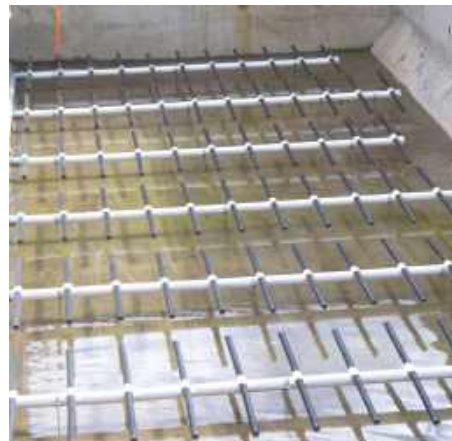

MODEL	SLIT SIZE	DESIGN FLOW	MAX AND MIN FLOW	ACTIVE SURFACE AREA	MOUNT	WEIGHT
AFT21000	1 MM	1.7 - 13.5 SM3/H	1.0 - 17.0 SM3/H	0,15 M2	SADDLE(*)	3200 GR
	2 MM	3.0 - 16.5 SM3/H	1.5 - 20.0 SM3/H			
AFT31000	1 MM	3.4 - 22.0 SM3/H	1.0 - 26.0 SM3/H	0,22 M2	SADDLE (*)	4500 GR
	2 MM	4.5 - 25 SM3/H	2.0 - 34.0 SM3/H			

Data is for L=1 m
(*) Also available with 3/4 NPT F threaded connection
Also available in 500 and 750mm lengths

AFT SERIES

Tube Diffusers

Together with a wide range of diffusers, SSI offers a series of accessories to make the creation of aeration systems faster, cheaper and more precise.

Saddle and Grommet Connections

- 3/4" NPT Female thread
- Grommets offer a practical and cost-effective solution for PVC systems with 90mm or 110/114.3mm diam pipe
- PP Saddles are available for 88.9/90 and 110/114.3mm diam pipe. Quick connect and bolted versions are available



Pipe accessories

- Unions between pipes can save on assembly costs
- Removable end cap for easy cleaning and inspection of pipe
- Expansion joints available to compensate for thermal variations



Piping Support stands

- Standard supports supplied in AISI304 with mechanical anchors. Also available in AISI316
- ABS Support stands also available in D90 and D110

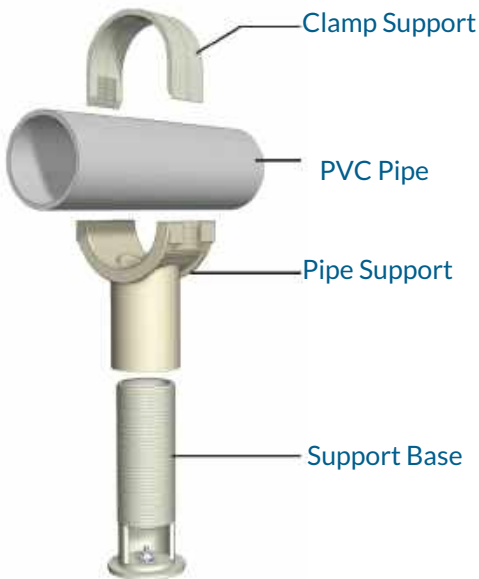

ACCESSORIES

ADVANTAGES OF A RETRIEVABLE SYSTEM

Retrievable systems are ideal for plants

- That have only one basin and can't take the basin down to perform maintenance
- If you want to check on the status of your aeration grids without draining the tanks
- With aggressive wastewater that requires frequent maintenance and checks

SSI has years of experience providing and designing retrievable aeration systems and grids

...some examples



Winch extractable system



Systems extractable by crane with disc diffusers (on the left) and tubes (on the right)

RETRIEVABLE SYSTEMS

WHY IS MAINTENANCE OF YOUR AERATION SYSTEM IMPORTANT?

Aeration systems represent about 1-2% of the total cost initial cost of a WWTP, however they are responsibly for 50-70% of the plants energy consumption.

By maintaining your diffusers you can help minimize any increases in energy cost and keep your system efficiently running.

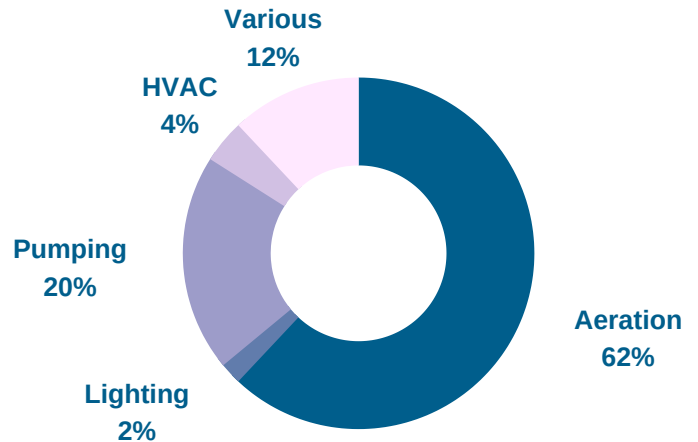

OUR SOLUTION

SSI can provide a reliable and economic solution to clean your diffusers and running efficiently.

Our acid dosing systems consist of

- A containment tank
- A dosing pump
- A special nozzle to atomize the acid

With an acid dosing system you can clean the diffusers without stopping the treatment process or emptying your tank!

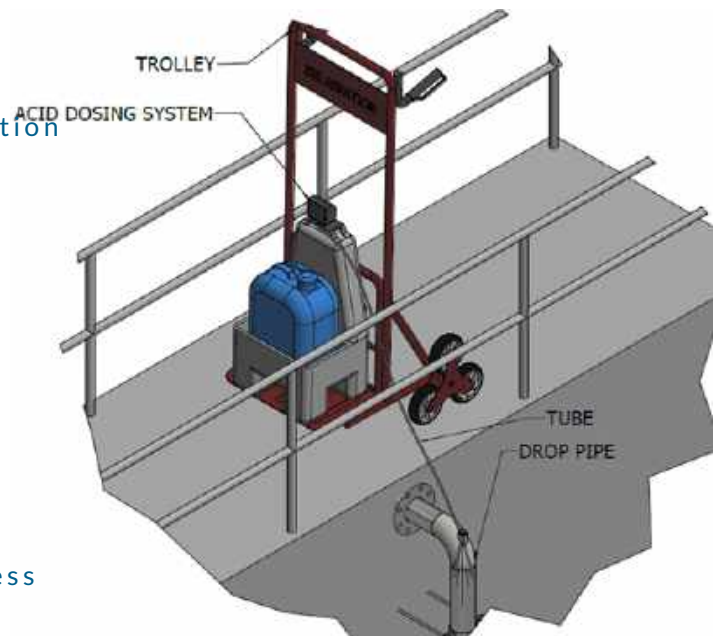

ACID DOSING SYSTEM

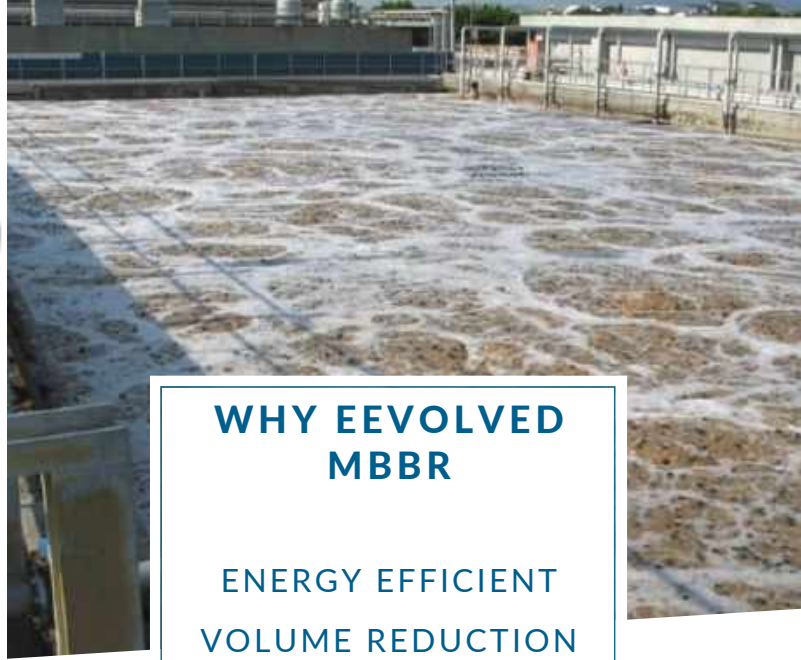

WHY EEVOLVED MBBR

ENERGY EFFICIENT
VOLUME REDUCTION
HIGH QUALITY
DISCHARGE

SSI HAS RETHINKED MBBR TECHNOLOGY

SSI's EEVolved MBBR technology provides efficient treatment while utilizing lower HRT values than any other biological treatment process.

By combining PTFE fine bubble diffusers with SSI media maximum treatment efficiency is achieved (compared to MBR, SBR, CAS and Granular technologies).

Advantages

An MBBR system made with EEVolved MBBR technology guarantees

Increase in

- Treatment efficiency
- Hydraulic capacity
- Versatility of the process
- Duration of the process
- Easier to manage sludge arriving at the secondary settler (no poly dosing)

Reduction of:

- Energy and operating costs
- Volumes of the reactor and HRT
- Process complexity
- Operator maintenance
- Maintenance

3 models available

- 630
- 675
- 870

EEVOLVED™ MBBR

MBBR Systems

SSI AERATION, INC.
WWW.SSIAERATION.COM
INFO@SSIAERATION.COM

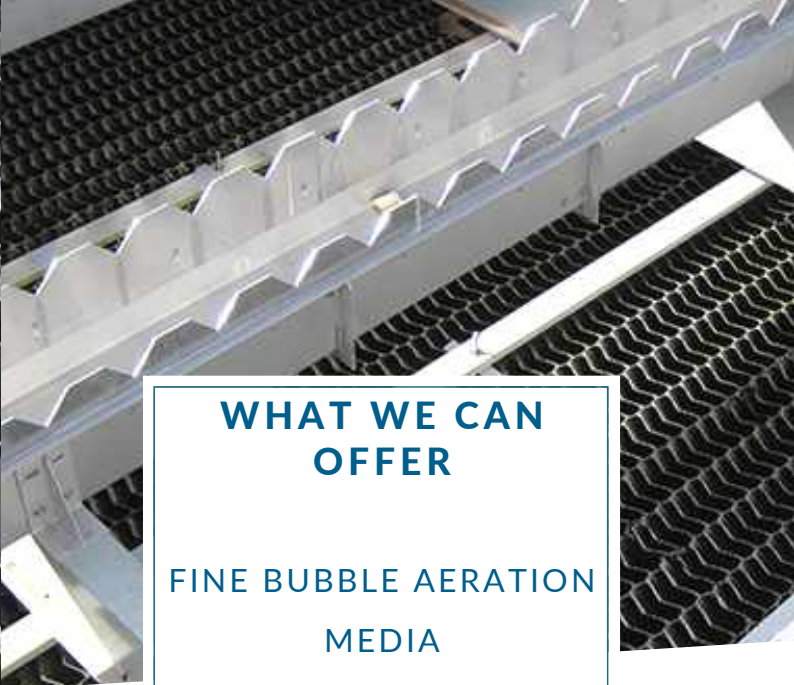

WHAT WE CAN OFFER

FINE BUBBLE AERATION
MEDIA
SCREENS
LAMELLA PACKS

Lamella Packs

- Developed to ensure the best performance in terms of efficiency, without increasing its size
- Available in PVC or PP
- Self-supporting (no external support skid)
- Chevron v shape with uniform passage minimizes the risk of clogging

What Can We Offer

The package that SSI can offer to guarantee process performance consists of:

- Aeration system with fine bubble diffusers and PTFE membranes
- Media
- Retention Screens
- Secondary settler with lamella packs

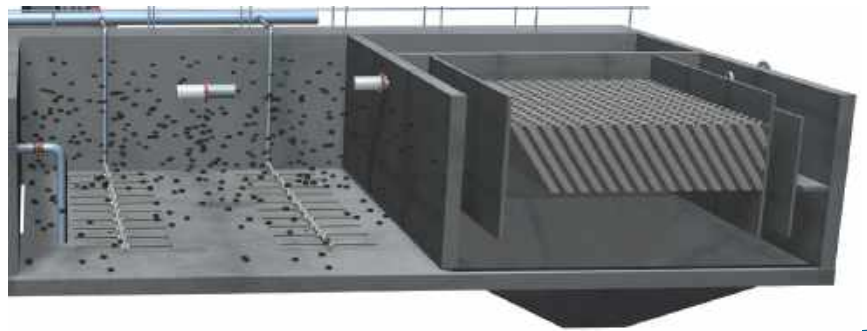

EEVOLVED™ MBBR

MBBR Systems

SSI AERATION, INC.
WWW.SSIAERATION.COM
INFO@SSIAERATION.COM



SSI boasts several references all around the world. To name a few:

- Ft. Worth Village Creek, Arlington, Texas
70000 diffusers 9" AFD270 in PTFE
- Bushkoppies WWTP, Johannesburg, South Africa
66000 diffusers 9" AFD270 in EPDM
- Wellington Dock, Liverpool UK
70000 diffusers 9" AFD270 in PTFE
- Valladolid WWTP, Spain
26900 membranes 9" in EPDM
- Blackburn WWTP, UK
42000 diffusers 9" ECD270 in EPDM
- Over 500 systems sold in Italy with over 15 years of presence on the Italian market
 - Depuratore Prealpi servizi di San Antonino
Over 10000 diffusers 9" ECD270 in EPDM
 - Depuratore HERA di Ravenna
2800 diffusers ECD270 in PTFE
 - Depuratore Lura ambiente di Origgio
Over 4500 diffusers 9" ECD270 in EPDM
 - Crotone, Milano 3Basiglio, Carimate, Campalto Vercelli, etc.

REFERENCES

Our Locations



Contacts:

SSI Aeration, Inc.
4 Tucker Drive
Poughkeepsie, NY 12603
info@ssiaeration.com
+1 (845) 454-8171

SSI AROUND THE WORLD

SSI AERATION, INC.
WWW.SSIAERATION.COM
INFO@SSIAERATION.COM